

Shouldered System

JANUARY 2025



Structural | Tubular | Bar | Plate | Stainless | Sheet & Coil | Plate
Aluminium | Wear Products | Pipes & Fittings | Walkway Systems | Fencing

Shouldered ERW Pipe

Specifications

The following specifications describe the requirements for hot dip galvanised shouldered pipe suitable for use with either forged steel or cast iron couplings. Furthermore the pipe is suitable, depending on fluid type and service conditions, for service up to AS4041 Class 2 pipe work in underground applications.

Size Range

OD (mm)	t (mm)	Standard Lengths	Mass In Kg/m	Max Recommended Working Pressure	Max Recommended Test Pressure Ambient Temp.
114.3	2.1	6.0m	5.86	3.6MPa	5.4MPa
114.3	2.1	6.5m	5.86		
165.1	2.5	6.0m	10.02	3.0MPa	4.5MPa
165.1	2.5	6.5m	10.02		
219.1	3.5	6.0m	18.60	3.1MPa	4.7MPa
219.1	3.5	6.5m	18.60		
323.9	4.8	6.0m	38.22	2.9MPa	4.35MPa
355.6	4.8	6.0m	41.52	2.6MPa	3.9MPa
457.0	4.8	6.0m	53.52	2.0MPa	3.1MPa
610.0	6.0	6.0m	89.37	1.9MPa	2.9MPa

Note: The above maximum recommended test and working pressures are applicable only to the pipe and only if;

- The only applied stresses are those from the internal fluid pressure
- The pipeline is designed using the appropriate standard applicable to its use.

762mm and 914mm also available on application.



Surface Finish

Hot dip galvanised minimum coating thickness at any location of the product is 34microns, and the minimum mass per square metre of the coating shall be 300 g. Each pipe is visually inspected to ensure the coating on each pipe is adherent, smooth and free from dross, bubbles, spikes, lumps, flaking or peeling.

Bundling Data

OD (mm)	t (mm)	Standard Lengths	Mass In Kg/m	Lengths per Bundle	Mass per Bundle kg
114.3	2.1	6.0m	5.86	10	351.60
114.3	2.1	6.5m	5.86	10	380.90
165.1	2.5	6.0m	10.02	10	601.20
165.1	2.5	6.5m	10.02	10	651.30
219.1	3.5	6.0m	18.60	5	558.00
219.1	3.5	6.5m	18.60	5	604.50
323.9	4.8	6.0m	38.22	1	229.32
355.6	4.6	6.0m	51.52	1	309.12
457.0	4.8	6.0m	53.52	1	321.12
610.0	6.0	6.0m	89.37	1	536.22

Note: Sizes 114.3 through 219.1 shall be supplied bundled in accordance with the above table. A minimum of 4 straps per bundle shall be supplied.

Shouldered ERW Pipe

Chemical Composition

Coil feed material shall conform to API 5LB PSL1 chemical composition with special regard to Silicon content that ensures full adhesion of hot dipped galvanising.

Mechanical Properties

- Minimum Yield Strength: 245 MPa
- Minimum Tensile Strength: 415 MPa
- Minimum Elongation: 15%

Straightness and Length Tolerance

Pipes shall not deviate from a straight line by more than the length divided by 500 at the centre of the pipe length. Each pipe shall be the ordered length with a tolerance of -50.0mm, +20.0 mm.

End Squareness

Each pipe shall be cut with a squareness not exceeding 1.6mm.

Weld Bead

The external weld bead shall be trimmed to an essentially flush condition. The maximum height of the internal weld bead shall not exceed 1.5mm.

Mass

The mass of any mill length of pipe shall not be less than 98% of the nominal mass.

Roundness

Each pipe shall meet or exceed the requirements for Out-of-roundness as defined in API5L Specifications:

OD (mm)	Out-of-Roundness	
	Except Ends (mm)	Ends (mm)
114.3	2.29	1.72
165.1	3.30	2.48
219.1	4.38	3.29
323.9	7.03	5.27
355.6	7.11	5.33
457.0	9.14	6.86
610.0	12.20	9.15

Non-Destructive Testing

Traditional automated non-destructive examinations such as; Ultrasonic and Hydrostatic as outlined in API5L are completed on every length of pipe. Hydrostatic test pressures are calculated as follows and held for five (5) seconds.

$$P \text{ (MPa)} = \frac{1.2 \times YS \times t}{D}$$

Where YS = minimum YS of pipe (MPa) = and t = nominal thickness (mm)

This Hydrostatic Test as outlined in API5L is completed on every length of pipe after the shouldered ring has been welded to the pipe, but prior to the galvanisation process being conducted..

Identification and Documentation

The identity of each pipe is maintained though galvanising process to ensure that the correct Heat Number and Purchase Order Number is stencilled on each pipe. Each pipe is marked with the following in permanent ink:

- Diameter (mm)
- Manufacturing specification and grade
- Heat Number

Each pipe is traceable to a Test Certificate which shall be supplied to the purchaser. SI units shall be used. For at least each heat of steel, the Test Certificate shall contain, at minimum:

- Details of the pipe section, specification and grade.
- Measured Chemical composition, for each element intentionally added and each element in the IIW CEq formula.
- Bare pipe measured Yield Strength, Tensile Strength & Elongation.
- A statement of compliance for welding to AS3992.
- A statement of compliance with regard to the non-destructive test method used.
- A statement of compliance for coating to the galvanising Standard.

References

- AS/NZS 3679.1:1996 (Amd. 1 & 2) Structural steel Part 1: Hot-rolled bars & sections
- AS/NZS 3992:1998 (Amd. 1) Pressure equipment – Welding and brazing qualification
- AS 4041:2006 Pressure piping
- AS/NZS 4680:2006 Hot-dip galvanized (zinc) coatings on fabricated ferrous articles
- ISO 9001:2008 Quality management systems – Requirements
- ANSI/API Specification 5L 44th edition:2007 Specification for Line Pipe

Shouldered Couplings

The shouldered flexible couplings and piping system is simple in design. It consists of a self-sealing rubber gasket embracing two pipe ends and a coupling which encloses the gasket while engaging shouldered on the pipe ends.

The shouldered flexible coupling is leakproof under pressure or vacuum even when the pipeline is only partly full or under vibration.

The small space occupied by the flexible coupling, the ease with which it can be fitted into confined spaces, together with the quick and easy coupling of pipe lengths make the shouldered flexible coupling and piping system uniquely versatile.

The system provides for limited expansion and contraction and accommodates some longitudinal and angular movement.



Operating Features

Speed and Efficiency

Shouldered joints have two basic parts – two shouldered ends on pipes (or fittings) and a complete coupling.

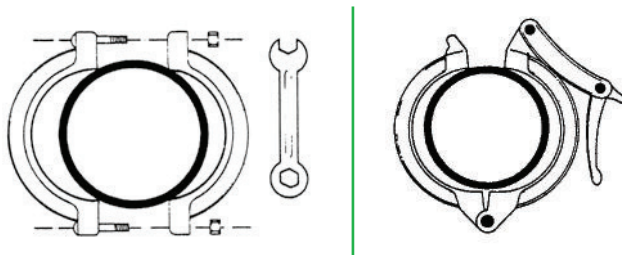

The toggle coupling is hinged and requires no bolts. It has two components:

- a rubber ring
- the hinged coupling

Flexibility

The shouldered system permits limited angular deflection in any direction without leakage so that uneven ground may be followed using straight pipes. Transmission of vibration from machines to pipelines can be minimised by using at least two adjacent shouldered joints.

Expansion and Contraction

Every shouldered joint in a straight pipeline allows for some contraction and expansion of the pipe length it connects.

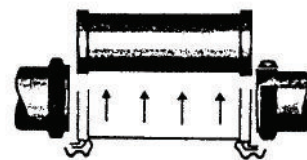
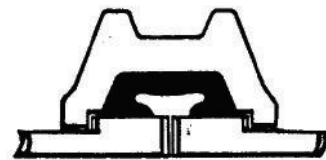

System Simplicity

Just as shouldered joints are easy to connect so they are easy to disconnect.

Dismantle two shouldered joints in a line and any individual pipe length, fitting or valve requiring maintenance, cleaning or repair can be quickly removed or replaced. Adjoining sections are undisturbed; pipe ends and joints are unharmed. This feature also permits easy rotation of pipes.

Shouldered Couplings

Locked Joint

- Shouldered couplings mechanically lock the shouldered pipe ends together securely and safely. The joints cannot blow off under pressure nor can they pull out under vibration or sag, because the shoulder sections of the couplings engage the circumference of the pipe shoulders.
- The shouldered coupling, when applied, automatically centralises the sealing ring and seats it on the pipe ends firmly.
- Line pressure automatically strengthens the seal by acting internally on the ring lips. The higher the pressure the tighter the seal.
- Suction or vacuum also automatically strengthens the seal. The higher outside atmospheric pressure acts to compress the walls of the shouldered ring.

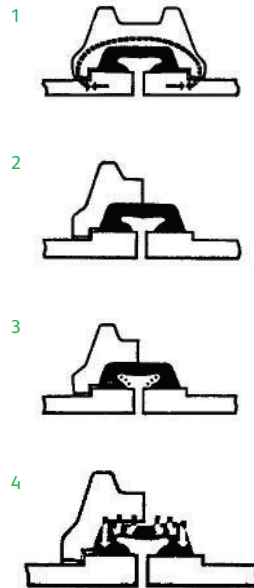

Assembly: Important:

- Pipe End Must be Smooth**
The shoulder must be smooth and any lumps of galvanising behind the shoulder or on the pipe ends removed.
- Lubrication**
Lubrication prevents the coupling nipping the ring and facilitates assembly. Smear lubricant over back of gasket (which comes in contact with the pipe ends). It is also helpful to smear the inside of the coupling. For water quality rings use soapy water. For oil quality rings use mineral oil or dip rings in the fluid to be conveyed before fitting.

Gaskets

Standard Gaskets			
Grade	Temp Range	Compound	General Service Recommendations
R	-50° to +65°	Natural Rubber	Typically used for hot water service within the specified temperature range, sewage plus a variety of dilute acids, oil free air, many chemical services and compressed air. Not advised for petroleum services.
N	-30° to +80°	Nitrile	Typically used for petroleum, oil or gas products, air with oil vapours, vegetable and mineral oils within the specified temperature range, except hot dry air over 60°C and water over 66°C. Not advised for hot water services.

Coatings

Couplings

- All galvanised couplings are hot dipped galvanised to AS 1650.
- All painted couplings are black painted to ASTM B117 (other colours subject to enquiry).

Bolts and Nuts – all bolts and nuts hot dipped galvanised to AS 1214.

Standard Two Part Couplings

Nominal Pipe Size mm	Pipe O.D. mm	Maximum recommended				Mass each complete Kg
		Test Pressure		Working Pressure		
		kPa	PSI	kPa	PSI	
50	60.3	22000	3190	4150	600	1.2
80	88.9	18000	2610	4150	600	1.5
100	114.3	12500	1810	4150	600	2
125	139.7	9000	1305	3000	435	3
150	165.1	9000	1305	3000	435	3.5
150	168.3	9000	1305	3000	435	3.8
200	219.1	8000	1160	2660	385	5.9
250	273.0	8000	1160	2660	385	9.1
300	323.9	8000	1160	2660	385	11.8
350	355.6	8000	1160	2660	385	15.4

Standard Two Part Couplings

Galvanised or black painted. 50 - 350mm.

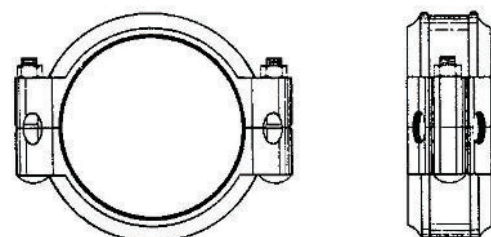

Shouldered Couplings

Standard Four Part Couplings

Galvanised or black painted 400 - 750mm nominal pipe size.

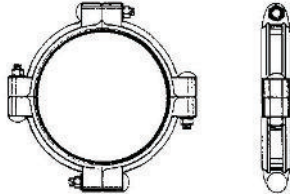

Nominal Pipe Size mm	Pipe O.D. mm	Maximum recommended				Mass each complete Kg
		Test Pressure		Working Pressure		
		kPa	PSI	kPa	PSI	
400	406.4	8000	1160	2660	385	25.4
450	457.0	8000	1160	2660	385	29.1
500	508.0	6000	870	2000	290	33.8
600	610.0	6000	870	2000	290	27.8

Heavy duty Couplings

Galvanised or black painted.

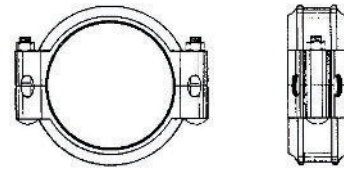

Nominal Pipe Size mm	Pipe O.D. mm	Maximum recommended				Mass each complete Kg
		Test Pressure		Working Pressure		
		kPa	PSI	kPa	PSI	
100	114.3	22000	3190	6900	1000	4.7
150	165.1	18000	2755	6900	1000	6.2
150	168.3	18000	2755	6900	1000	6.8
200	219.1	18000	2755	6900	1000	14.2

Victaulic SC85 Couplings

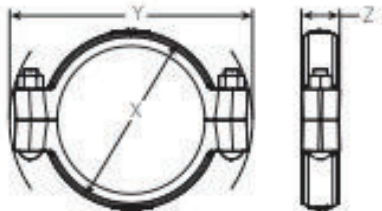

Style SC85 Joint Assembled
2 - 8°/DN50 - DN200

Pipe Sizes		Coupling Dimensions			Weight
Nominal Size mm	Pipe O.D. mm	X mm	Y mm	Z mm	
50	60.3	92	143	48	1.1
80	88.9	127	181	48	1.6
100	114.3	152	218	51	2.2
150	165.1	207	286	51	3.5
200	219.1	273	375	61	6.5
250	273.0	330	452	71	12.0
300	323.9	381	502	71	14.0
350	355.6	413	530	76	17.3
400	457.00	537	641	86	26.6

Maximum Working Pressure – Up to 4200 kPa dependent on size of pipe.

Victaulic W77 Flexible AGS Couplings

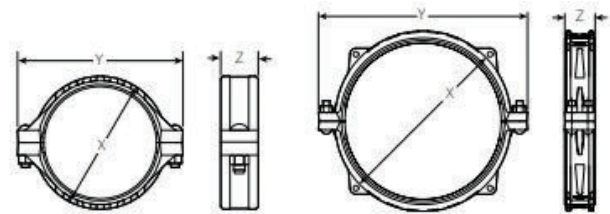

Typical 12 - 24°/300 - 600mm

Typical 26 - 60°/660 - 1500mm

Pipe Sizes		Coupling Dimensions			Weight
Nominal Size mm	Pipe O.D. mm	X mm	Y mm	Z mm	
300	355.6	406	524	114	21.8
350	406.4	464	597	114	26.8
400	457.2	517	647	114	29.5
450	508.0	575	689	114	37.2
500	558.8	628.7	743	114	44.5
550	609.6	683	822	114	48.5
600	660.4	765	895	146	93.0
650	711.2	829	945	146	99.8
700	812.8	863	1007	146	103
750	865.8	916	1060	146	109.8
800	914.4	972	1111	146	115.7
850	865.2	1022	1161	146	121.6
900	865.4	1048		146	135

Maximum Working Pressure – Up to 2413 kPa dependent on size of pipe.

Shouldered Couplings

Victaulic SC77 Couplings

The Victaulic SC77 Shouldered Coupling utilizes patented Installation-Ready quick fit technology allowing the coupling to be installed without completely removing the bolts. .

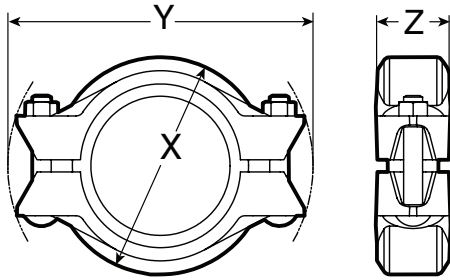

Nominal Size mm	Pipe O.D. mm	Coupling Dimensions			Weight
		X mm	Y mm	Z mm	
50	60.3	102	152	52	1
80	88.9	159	197	52	1.5
100	114.3	159	222	57	1.9
150	165.1	216	194	57	3.1
200	219.1	279	362	73	5.6

Maximum Working Pressure – Up to 4000 kPa dependent on size of pipe.

Shoulder Rings

Weld-on steel shoulder rings provide an interference fit with the outside of the pipe ends and therefore must be a neat tight fit.

Care is required when fitting shoulder rings to ensure that ring distortion does not occur. It is equally important that the distance between the edge of the steel shoulder ring and the pipe end be accurately maintained. If this “Stand Off” is exceeded, distortion will occur.

Stand Off

5mm for pipe 88.9mm outside diameter and below. 6.5mm for pipe 114.3mm outside diameter up to and including 762mm outside diameter.

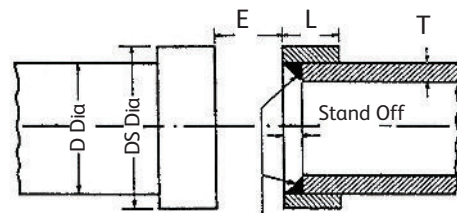

Full fillet. Circumferential weld here

Nominal Pipe Size mm	Outside Diameter mm	"D" Diameter mm	"DS" Diameter mm	Shoulder Dimensions		
				Tolerance		"L" Dimension mm
				Plus mm	Minus mm	
50	60.3	60.3	66.5	0.8	0.8	16
80	88.9	88.9	97	0.8	0.8	16
100	114.3	114.3	122	0.8	0.8	17.5
125	139.7	139.7	149	0.8	0.8	17.5
150	165.1	165.1	174.5	0.8	0.8	17.5
150	168.3	168.3	178	0.8	0.8	17.5
200	219.1	219.1	232	0.8	1.4	20.5
250	273.0	273.0	286	0.8	1.9	20.5
300	323.9	323.9	336.5	0.8	2.4	20.5
350	355.6	355.6	368.5	0.8	2.4	24
400	406.4	406.4	419	0.8	2.4	25.5
450	457	457	470	0.8	2.4	25.5
500	508	508	520.5	0.8	2.4	25.5
550	559	559	571.5	0.8	2.4	25.5
600	610	610	622.5	0.8	2.4	25.5
650	660	660	673.1	0.8	2.4	25.5
700	711	711	723.9	0.8	2.4	25.5
750	762	762	774.7	0.8	2.4	25.5

Shouldered Fittings



Adjustable Bends

The adjustable Bend consists of two special goosenecked setting pieces (united by a standard flexible coupling) which normally can be used for any angle from 0 to 45° and can be set at any angle in this range in two or three minutes. By the addition of a 45° elbow, any angle up to 90° can be obtained..

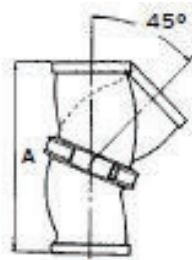

Bends

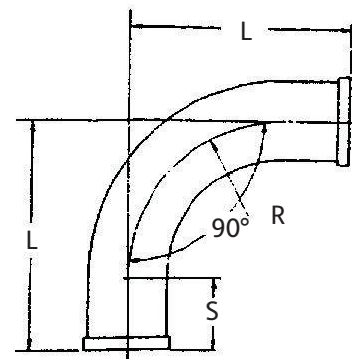

Nominal Pipe Size mm	To Suit Pipe Outside Diameter mm	'A' Minimum Length End to End mm
50	60.3	197
80	88.9	229
100	114.3	264
150	165.1	333
150	168.3	333
200	219.1	394
250	273.0	445
300	323.9	495

Nominal Pipe Size mm	To Suit Pipe Outside Diameter mm	'L' Centre to Face mm	'R' Bend Radius mm	'S' Minimum Length of Straight mm
50	60.3	222	146	76
80	88.9	305	238	67
100	114.3	425	308	117
150	165.1	610	457	152
150	168.3	610	457	152
200	219.1	914	711	203
250	273.0	1575	1270	305
300	323.9	1880	1524	356

Note: Larger sizes available on enquiry

Shoulder Fittings

Blank Ends

Blank Ends for fitting into the standard coupling can be supplied either plain, or tapped for testing purposes. They are of the same diameter as the shouldered pipe end, and are capable of carrying the full end pressure in the pipe.

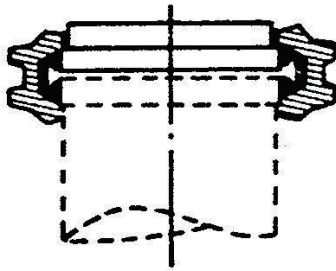

Nominal Pipe Size mm	To Suit Pipe Outside Diameter mm
50	60.3
80	88.9
100	114.3
150	165.1
150	168.3
200	219.1
250	273.0
300	323.9

Note: Larger sizes available on enquiry

Adaptors

Shouldered to screwed B.S.P. male thread adaptor. Shouldered to flanged adaptor..

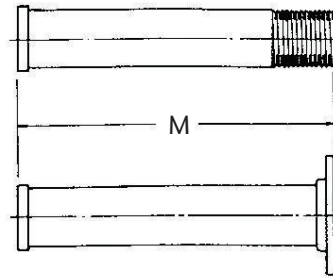

Nominal Pipe Size mm	To Suit Pipe Outside Diameter mm	'M' Minimum Over all Length	
		Standard mm	Short Pattern mm
50	60.3	318	100
80	88.9	423	100
100	114.3	470	100
150 Flanged	165.1/ 168.3	507	100
150 Screwed	165.1	507	150
200	219.1	605	100
250	273	757	100
300	323.9	909	100

Note: (i) Larger sizes available on enquiry
(ii) Flanged pieces are normally supplied with Table 'D' flanges drilled. Other flange tables are available on enquiry.
(iii) Screwed adaptors available 50 - 150mm only.

Crosses

Nominal Pipe Size mm	To Suit Pipe Outside Diameter mm	'C' Centre to Face mm
50	60.3	152
80	88.9	203
100	114.3	229
150	165.1	254
150	168.3	254
200	219.1	305
250	273.0	381
300	323.9	457

Note: Larger sizes available on enquiry

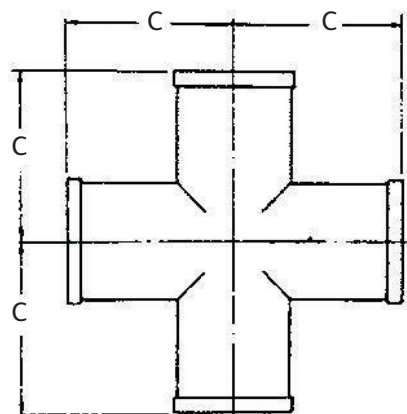

Shouldered Fittings

Elbows 90° and 45°

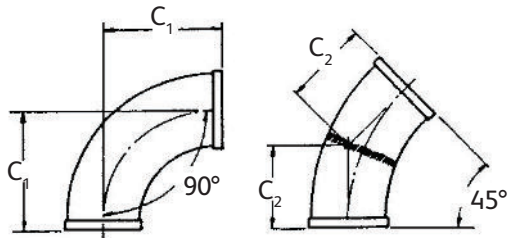

Nominal Pipe Size mm	To Suit Pipe Outside Diameter mm	'C' Centre to Face		'C' Centre to Face 45° Elbows mm
		Standard mm	Short Pattern mm	
50	60.3	152	69	78
80	88.9	203	91	109
100	114.3	229	110	135
150	165.1	254	148	173
150	188.3	254	148	173
200	219.1	305	183	235
250	273.0	381		
300	323.9	457		

Note: Larger sizes available on enquiry

Reducers

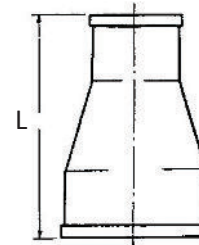

Nominal Pipe Size mm	To Suit Pipe Outside Diameter mm	'L' Minimum Length End to End	
		Standard mm	Short Pattern mm
50	60.3		
80	88.9	203	90
100	114.3	229	112
150	165.1	305	150
150	168.3	305	150
200	219.1	330	162
250	273.0	381	
300	323.9	457	

Note: Larger sizes available on enquiry

Offset Tees

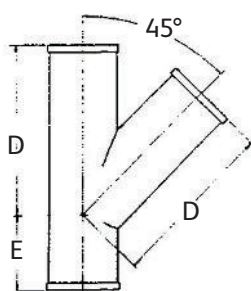

Nominal Pipe Size mm	To Suit Pipe Outside Diameter mm	'D' Centre to Face mm	'E' Centre to Face mm
50	60.3	215	89
80	88.9	279	127
100	114.3	343	115
150	165.1	394	114
150	168.3	394	114
200	219.1	470	140

Note: Larger sizes available on enquiry

Y-Pieces

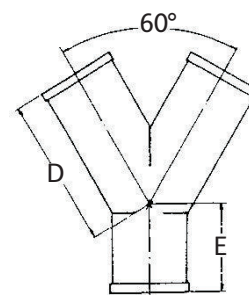

Nominal Pipe Size mm	To Suit Pipe Outside Diameter mm	'D' Centre to Face mm	'E' Centre to Face mm
50	60.3	165	89
80	88.9	229	127
100	114.3	279	127
150	165.1	330	152
150	168.3	330	152
200	219.1	381	178

Note: Larger sizes available on enquiry

Shouldered Fittings

Pieces

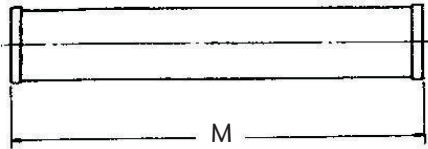

Nominal Pipe Size mm	To Suit Pipe Outside Diameter mm	'M' Minimum Overall Lengths Available mm		
50	60.3	300	600	900
80	88.9	300	600	900
100	114.3	300	600	900
150	165.1	300	600	900
150	168.3	300	600	900

Note: Exact lengths available on enquiry

Springs

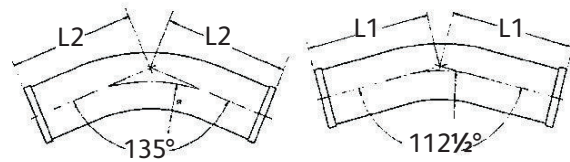

Nominal Pipe Size mm	To Suit Pipe Outside Diameter mm	'L' Centre to Face 112½° Spring mm	'L' Centre to Face 135° Spring mm	'R' Radius mm
50	60.3	197	187	146
80	88.9	273	260	238
100	114.3	378	365	308
150	165.1	546	521	457
150	188.3	546	521	457
200	219.1	819	778	711
250	273.0	1422	1346	1270
300	323.9	1702	1600	1524

Note: Larger sizes available on enquiry

Setting Pieces

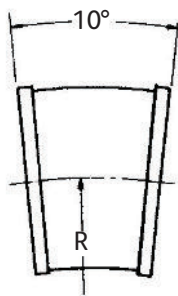

Nominal Pipe Size mm	To Suit Pipe Outside Diameter mm	'R' Radius mm
50	60.3	368
80	88.9	413
100	114.3	470
150	165.1	521
150	168.3	521
200	219.1	692
250	273.0	876
300	323.9	978

Note: Larger sizes available on enquiry

Tees

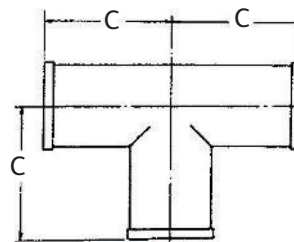

Nominal Pipe Size mm	To Suit Pipe Outside Diameter mm	'C' Centre to Face	
		Standard mm	Short Pattern mm
50	60.3	152	69
80	88.9	203	91
100	114.3	229	110
150	165.1	254	148
150	168.3	254	148
200	219.1	305	183
250	273.0	381	
300	323.9	457	

Note: (i) Larger sizes available on enquiry
(ii) Reducing Tees also available in above sizes with outlet branches including:
(a) Screwed standard B.S.P. male thread.
(b) Screwed B.S.P. female (parallel) thread.

Shouldered Fabricated Products

Access to our fabrication facilities is assured through our dedicated InfraBuild Piping Systems locations and support service centres across Australia. Our Australian-made products can be customised to various design specifications by our committed team who have delivered fabricated components and products for over 30 years.



Shouldered/Flanged Pressure Reducing Station made to your requirements

Manifolds

Manifolds can be fabricated to your design and application, using various specifications, supplied fully assembled using quality components and painted.

Alternatively, select from our comprehensive range of hot dipped galvanised manifolds.



Gas Extraction

We manufacture and assemble a range of products required for gas extraction, which can be fabricated to your design and application, using various specifications. Products currently supplied include:

- Copper draw point pipes
- Collector manifolds
- Elbows, Tees and Caps
- Isolating and check valve assemblies
- Water traps



Hydrants

Hydrants and droppers are fabricated to suit the customer's requirements and conditions. Connections and offtakes are made to suit all fire and water hose accessories that are commonly used in mining.



Shouldered Valves

We stock a range of shouldered valves for a variety of applications and pressure ratings. Gate, Butterfly, Ball and Check Valves can be supplied as a complete unit or with shouldered adaptors to suit your pipeline.



Victaulic 752L Gate Valve



Sureflow 3500 kpa Gate Valve



Victaulic Vic-300 MasterSeal
Butterfly Valve



Wafer Style Butterfly Valve
c/w Shouldered Adaptors



Check Valve c/w Shouldered Adaptors



Screwed Ball Valve c/w Shouldered Adaptors

InfraBuild's mining program

InfraBuild has been a presence in many rural and remote communities for over 100 years, supplying our customers with materials and steel processing services.

At InfraBuild we place great importance on working closely with our customers to support community growth and long-term sustainable relationships across the country.

We live and work in regional communities and are well positioned to supply product into many industries that

keep our economy thriving, including MMP (mining, minerals, processing).

As a manufacturer and distributor of materials critical to MMP, we understand the importance of predictability by having the right stock in the right place at the right time. Producing quality materials delivered on time as promised for an agreed price, we create value for our customers through a continuous improvement philosophy and experienced local representation.



Our Customer-Focused Mining Offer and Program

At InfraBuild, we understand the importance of meeting deadlines and reducing the stresses own contract managers. We do this by appointing a single point of contact, a corporate relationship manager, from InfraBuild Steel centre, who will:

- Manage they contract and communication between the different stakeholders within your company and InfraBuild
- Act as a single point of contact at the contract level
- Act as a facilitator across all programmes agree with you

InfraBuild Steel Centre can help businesses like yours, which are often cost and time constrained, through our full-service approach for steel supply. We offer a package of exclusive 'tools' and resources aimed at adding value to your business through innovation and continuous improvement. Areas of focus include:

- Customised service offer
- Innovative solutions
- Cost saving initiative generation
- Total cost of ownership (TCO) analysis
- Gap analysis
- Undertaking reporting requirements
- Risk reduction

Other Mining Products We Offer

- Hot rolled structural, Merchant bar, Steel plate, wear plate
- Pipe fittings – screwed, buttweld, flanges (carbon and stainless steel)
- Grooved and shouldered mechanical jointing systems
- Poly piping systems
- Valves
- Tube (carbon and stainless steel)
- Fencing
- Roadside barriers
- Rail and sleepers and track accessories
- Ground support
- Culverts

Mining Product Quality

InfraBuild's Mining product range and supply services have been continuously developed and refined over the past 30 years. InfraBuild supplies high quality mining products which benefit our customers by minimising variation and reducing waste.





InfraBuild
Building futures through sustainable steel

Find your
InfraBuild Steel Centre:
www.infrabuild.com

Please note that any specifications or technical data referred to in this publication are subject to change and/or variation or improvement without notice and no warranty as to their suitability for any use is made. Photographs shown are representative only of typical applications. This brochure is not an offer to trade and shall not form any part of the trading terms in any transaction. Copyright 2023 InfraBuild Trading Pty Limited (ABN 50 007 519 646).

